

















ACESSÓRIOS

A  8x	B  Ø 15 mm 8x	C  Ø 12 x 12 mm 56x	D  Ø 10 x 10 mm 30x
E  Ø 5.0 x 50 mm 32x	F  Ø 3.5 x 14 mm 50x	G  Ø 3.0 x 12 mm 8x	H  Ø 13 mm 8x
I  8x	J  400 mm 2x	K  4x	L  Ø 1/4 x 2"1/2 mm 8x
M  8x	N  Ø 26 mm + CALÇO 12 MM 2x	O  Ø 8 x 30 mm 36x	P  46 x 15 x 4 mm 6x



Medidas em mm

OBSERVAÇÕES IMPORTANTES

**LIMPE COM UM PANO LIMPO E UMEDECIDO
EM ÁGUA E SABÃO NEUTRO.
NÃO UTILIZAR PRODUTOS
QUÍMICOS E ABRASIVOS**



Necessário para Montagem

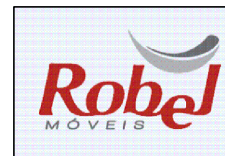
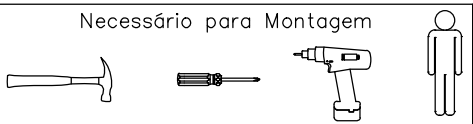

ROBEL - Ind. de Móveis Ltda.

AV. FELICIANO SALES CUNHA, 2999- JARDIM NOVO AEROPORTO
CEP 15035-000 SÃO JOSÉ DO RIO PRETO
FONE: +055 (17) 3203-0400 - FAX +055 (17) 3203- 0404

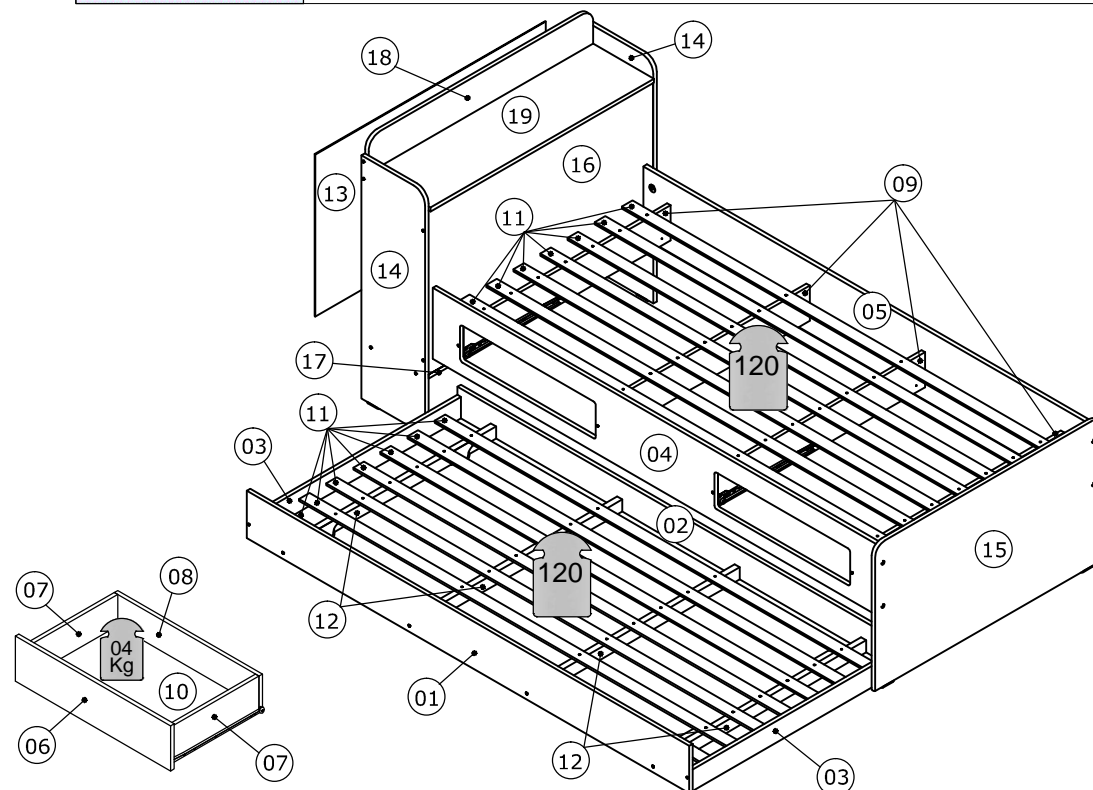

COD.	DESCRIÇÃO	QTD.	COD.	DESCRIÇÃO	QTD.
01	BARRA LATERAL FRONTAL AUX.	01	11	RIPAS	14
02	BARRA LATERAL TRASEIRA AUX.	01	12	TRAVESSA ESTRADO	04
03	PAINEL FRONTAL AUXILIAR	02	13	FUNDO TRASEIRO	01
04	BARRA LATERAL C/ RECORTE	01	14	LATERAL DIREITA e ESQUERDA	02
05	BARRA LATERAL	01	15	PESEIRA	01
06	FRENTE DA GAVETA	02	16	PAINEL	01
07	LATERAL DE GAVETA	04	17	FUNDO DO BAÚ	01
08	CONTRA FUNDO	02	18	PAINEL SUPERIOR	01
09	TRAVESSA DA GAVETA	04	19	TAMPO DO BAÚ	01
10	FUNDO GAVETA	02			

16.063 CAMA BIBOX COM BAÚ ONIX

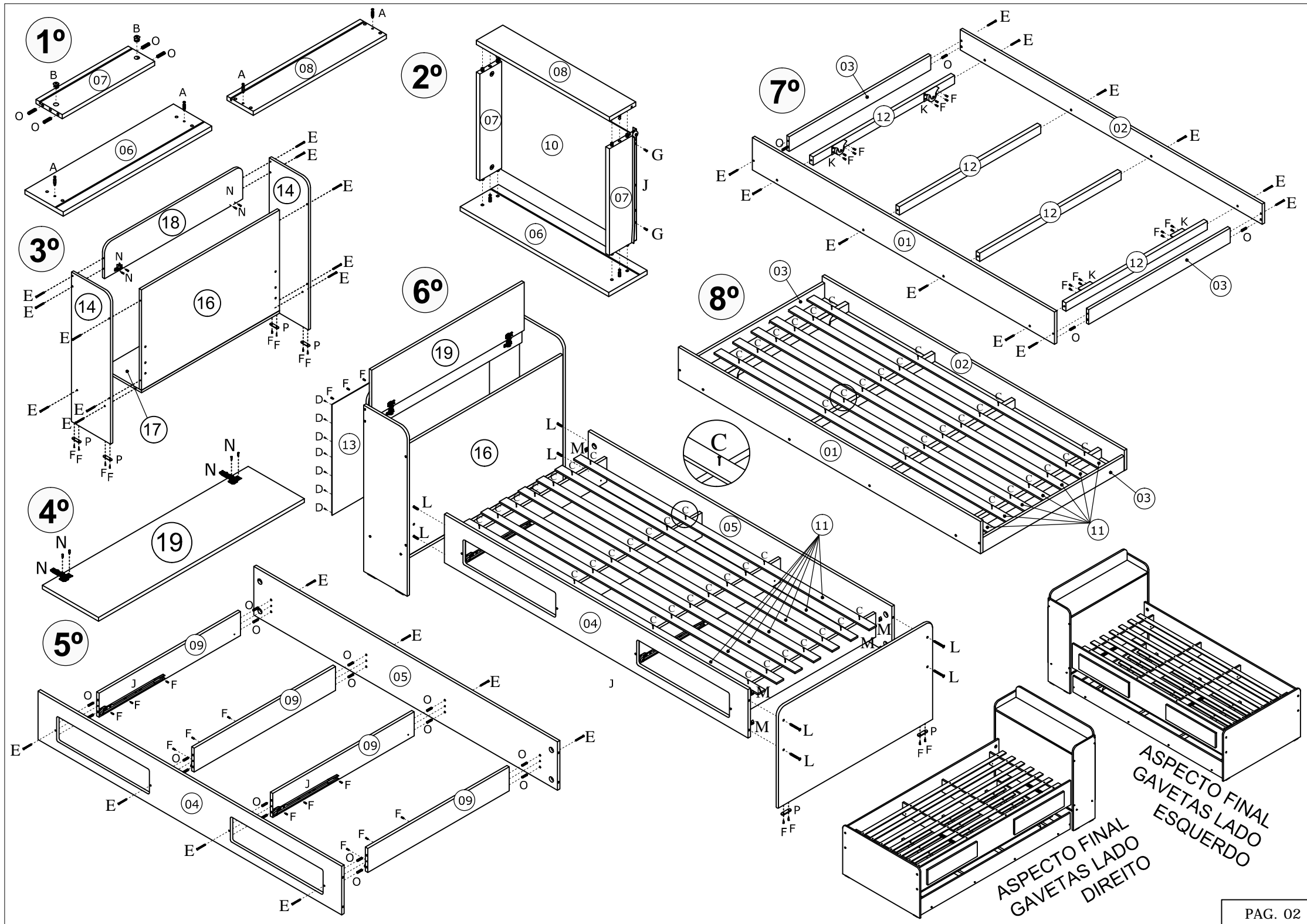

1°

2°

7°

3°

6°

8°

4°

5°

C

ASPECTO FINAL
GAVETAS LADO
ESQUERDO

ASPECTO FINAL
GAVETAS LADO
DIREITO