

















## ACESSÓRIOS

<b>A</b>  Ø 5,0 x 50 mm <b>7x</b>	<b>B</b>  Ø 13 mm <b>4x</b>	<b>C</b>  <b>12x</b>	<b>D</b>  Ø 5,5 x 65 mm <b>4x</b>
<b>E</b>  Ø 6 x 30 mm <b>24x</b>	<b>F</b>  <b>4x</b>	<b>G</b>  Ø 15 mm <b>4x</b>	<b>H</b>  <b>4x</b>
<b>I</b>  <b>1x</b>	<b>J</b>  <b>4x</b>	<b>K</b>  Ø 10 x 10 mm <b>60x</b>	<b>L</b>  Ø 3,5 x 14 mm <b>24x</b>
<b>M</b>  <b>6x</b>	<b>N</b>  <b>4x</b>	<b>O</b>  <b>4x</b>	<b>P</b>  Ø 3,5 x 14 mm <b>32x</b>



NECESSÁRIO PARA MONTAGEM

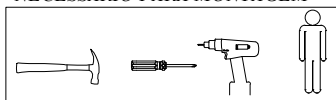

**ROBEL - Ind. de Móveis Ltda.**

AV. FELICIANO SALES CUNHA, 2999- JARDIM NOVO AEROPORTO

CEP 15035-000 SÃO JOSÉ DO RIO PRETO

FONE: +055 (17) 3203-0400 - FAX +055 (17) 3203- 0404

## OBSERVAÇÕES IMPORTANTES

LIMPE COM UM PANO LIMPO E UMEDECIDO EM ÁGUA E SABÃO NEUTRO.  
NÃO UTILIZAR PRODUTOS QUÍMICOS E ABRASIVOS

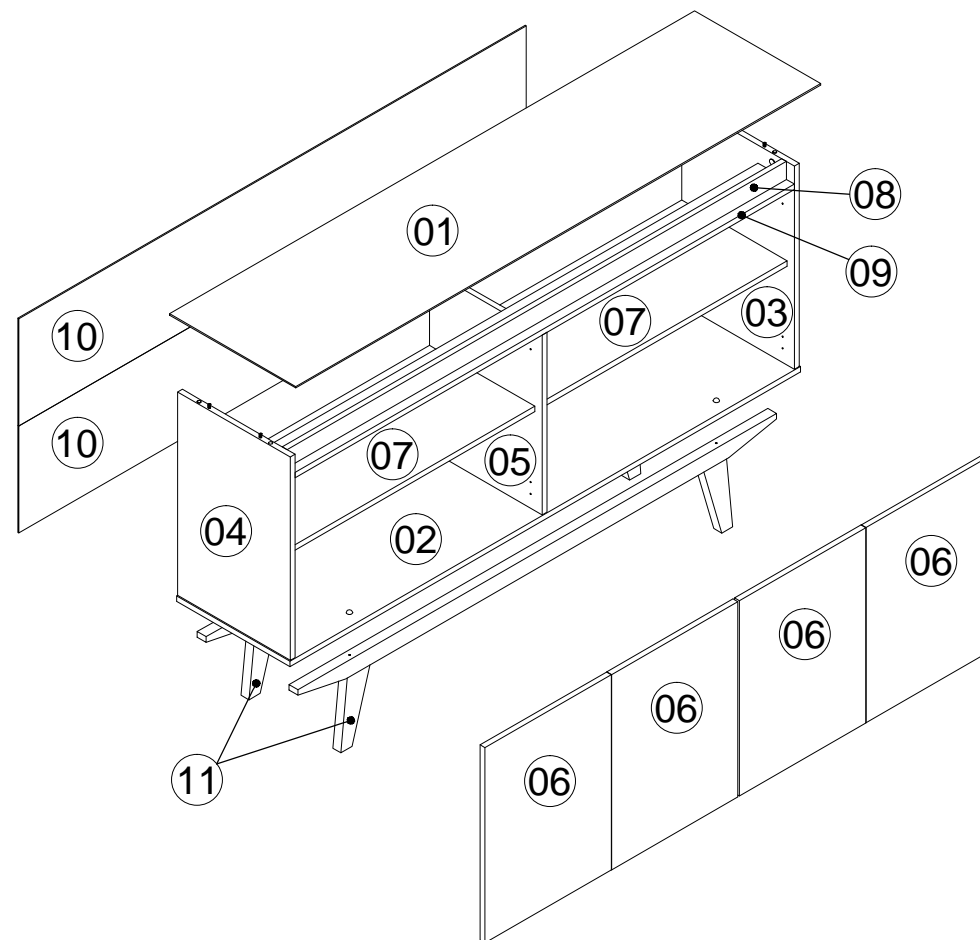

COD.	DESCRIÇÃO	QTD.
01	TAMPO DE CIMA	01
02	BASE	01
03	LATERAL DIREITA	01
04	LATERAL ESQUERDA	01
05	DIVISÓRIA	01
06	PORTA	04

COD.	DESCRIÇÃO	QTD.
07	PRATELEIRA	02
08	VISTA FRONTAL	01
09	BATEDOR DAS PORTAS	01
10	FUNDO TRASEIRO	02
11	BASE DE MADEIRA	02

15.881 - BUFFET 1,60

